















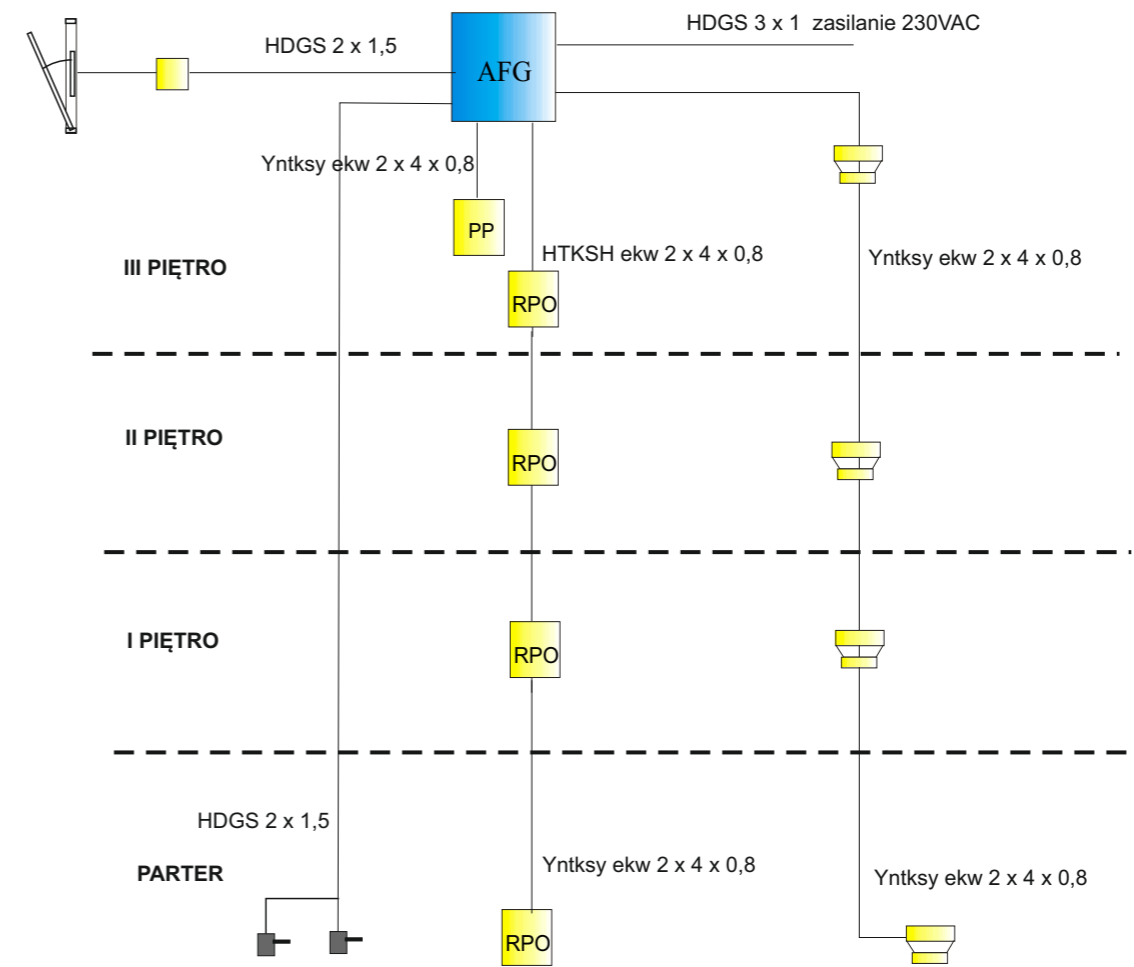
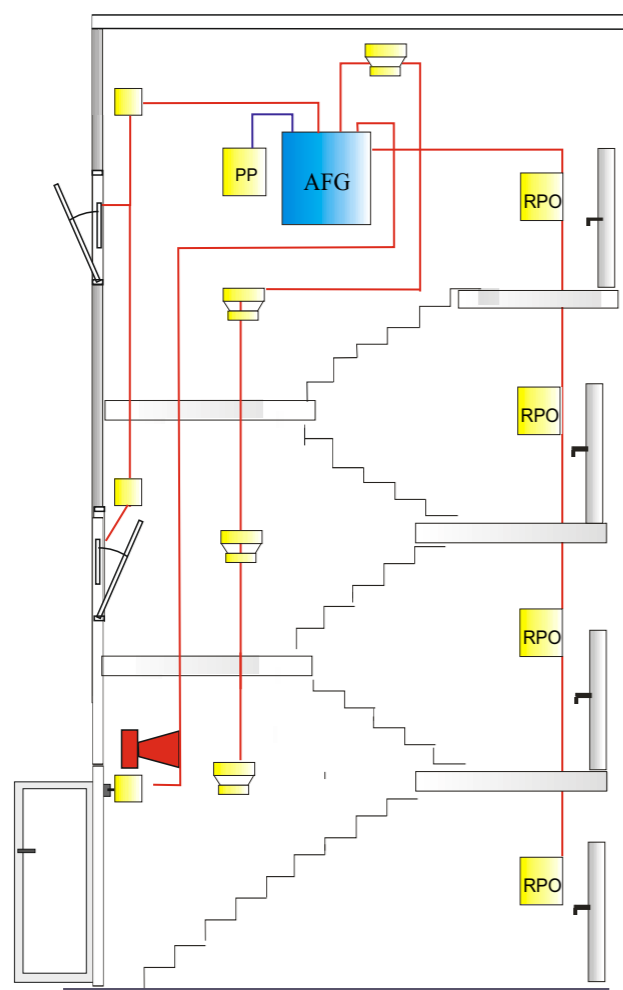

-  sygnalizator akustyczny
-  napęd okna
-  puszka PIP
-  napęd drzwi
-  czujka dymu
-  przycisk oddymiania
-  przycisk przewietrzania
-  centrala oddymiania



schemat instalacji oddymiania klatki schodowej K01  
okno oddymiające



-  sygnalizator akustyczny
-  napęd okna
-  puszka PIP
-  napęd drzwi
-  czujka dymu
-  przycisk oddymiania
-  przycisk przewietrzania
-  centrala oddymiania

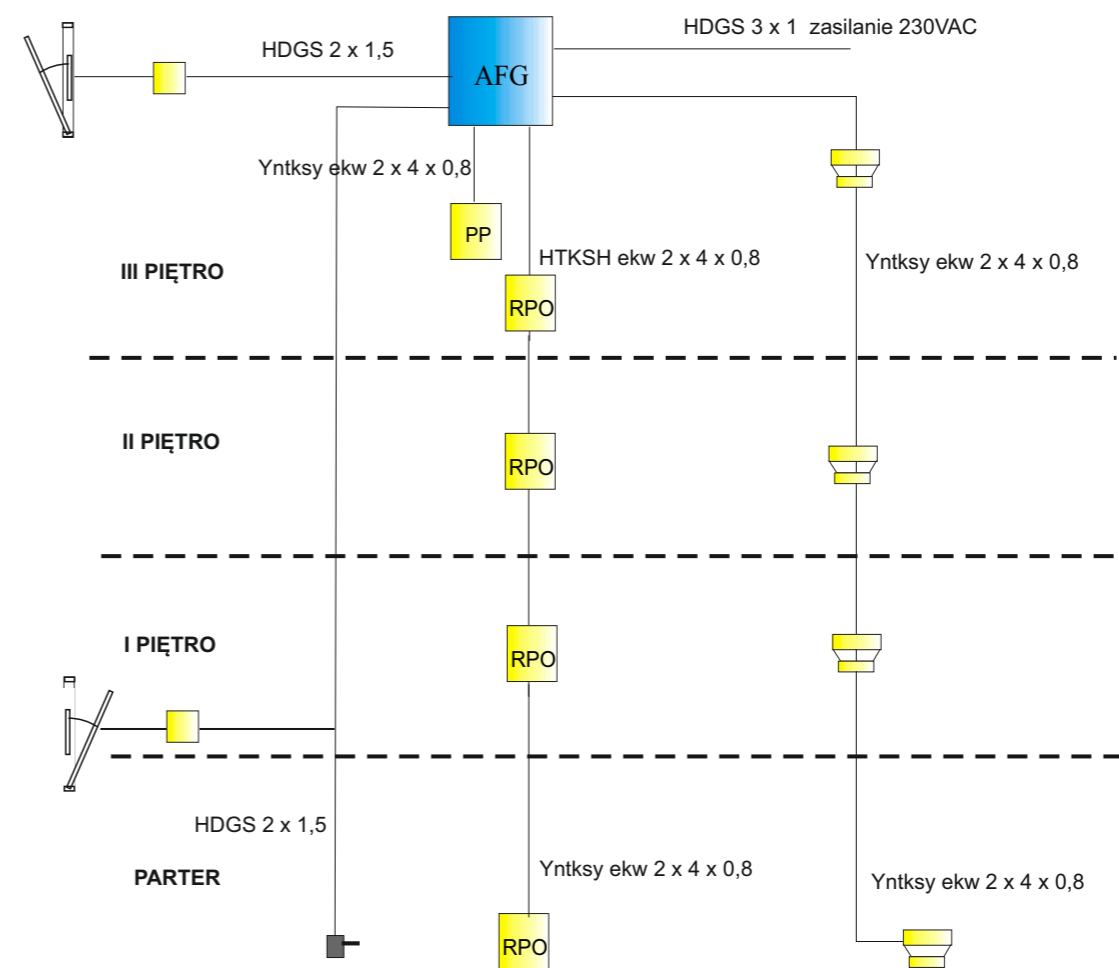

schemat instalacji oddymiania klatki schodowej K02  
okno oddymiające